

Vertical outside 90 with mounting holes & splice plates

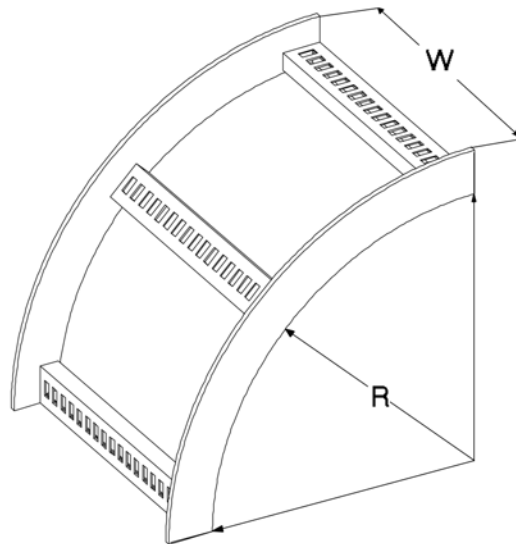

- **Rail: 3" flat rail**
- **Rung Spacing: 12" centers standard (other spacing available)**
- **Tangents: (optional) 4 1/2" tangent with 7/16" holes**

Width	Radius	Hot Dip Galvanized		Dement Coat	Sigma 3		304 Stainless Steel		316 Stainless Steel
		Product #	Weight (lbs.)	Product #	Product #	Weight (lbs.)	Product #	Weight (lbs.)	Product #
6"	12"	110-041A0609	7.00	110-042A0609	110-043A0609	6.25	110-044A0609	6.75	110-045A0609
6"	24"	110-041B0609	13.00	110-042B0609	110-043B0609	11.50	110-044B0609	12.75	110-045B0609
9"	12"	110-041A0909	7.25	110-042A0909	110-043A0909	6.50	110-044A0909	7.00	110-045A0909
9"	24"	110-041B0909	13.75	110-042B0909	110-043B0909	12.25	110-044B0909	13.50	110-045B0909
12"	12"	110-041A1209	7.75	110-042A1209	110-043A1209	6.75	110-044A1209	7.50	110-045A1209
12"	24"	110-041B1209	14.75	110-042B1209	110-043B1209	13.25	110-044B1209	14.50	110-045B1209
18"	12"	110-041A1809	8.50	110-042A1809	110-043A1809	7.50	110-044A1809	8.25	110-045A1809
18"	24"	110-041B1809	16.25	110-042B1809	110-043B1809	14.50	110-044B1809	16.00	110-045B1809
24"	12"	110-041A2409	9.25	110-042A2409	110-043A2409	8.25	110-044A2409	9.00	110-045A2409
24"	24"	110-041B2409	18.00	110-042B2409	110-043B2409	16.00	110-044B2409	17.75	110-045B2409
30"	12"	110-041A3009	10.25	110-042A3009	110-043A3009	9.00	110-044A3009	10.00	110-045A3009
30"	24"	110-041B3009	19.50	110-042B3009	110-043B3009	17.50	110-044B3009	19.25	110-045B3009
36"	12"	110-041A3609	11.00	110-042A3609	110-043A3609	9.75	110-044A3609	10.75	110-045A3609
36"	24"	110-041B3609	21.25	110-042B3609	110-043B3609	19.00	110-044B3609	21.00	110-045B3609



Electro Mechanical Industries
P.O. BOX 79689
Houston, Texas 77279-9689
Fax: 713-465-9771

Office: 713-465-6828

Toll: 800-453-0050